



Datafox GmbH • Dermbacher Straße 12-14 • D-36419 Geisa • [www.datafox.de](http://www.datafox.de)

# Manual

# Datafox IPC Vario 10

Flexible data collection with method



## Changes

### Changes in this document

Date	Chapter	Description
06.02.2013	all	New version in English

Please also follow the instructions given in the chapters of the manual. The updates are available in the download area of our homepage [www.datafox.de](http://www.datafox.de).

**Note:**

Useful information which helps you avoiding possible mistakes during the installation, configuration and commissioning is given here.

### © 2013 Datafox GmbH

This document has been created by Datafox GmbH and is copyrighted against third parties. Datafox GmbH considers all contained information, knowledge and depictions as its sole property. All rights, including also translation, reprint or copy of the whole document or parts of it, require written consent of Datafox GmbH. The assertion of all rights in this respect is reserved to Datafox GmbH, especially in case of the grant of a patent. The handover of this documentation does not establish a claim to the license or the use of the soft- and hardware. Copies of the floppy disks and CDs may only be made for the purpose of data backup. Every unauthorized copy of this documentation or the Datafox software will be prosecuted.

## Content

<b>1.</b>	<b>For Your Safety</b>	<b>1</b>
<b>1.</b>	<b>Introduction</b>	<b>2</b>
1.1.	Structure of the Documentation .....	2
1.2.	Guarantee Restriction.....	2
1.3.	Typography of the Documentation.....	3
1.4.	Important General Notes .....	3
<b>2.</b>	<b>Intended Use and Environmental Protection</b>	<b>4</b>
2.1.	Regulations and Notices.....	4
2.2.	Power Supply.....	4
2.3.	Environmental Influences .....	4
2.4.	Handling of the Touch Screen Display .....	4
2.5.	Maintenance / Repair.....	4
2.6.	Further Notices .....	4
2.7.	Disposal .....	4
<b>3.</b>	<b>Product Description</b>	<b>6</b>
3.1.	Purpose .....	6
3.2.	Controls at the Front Side.....	6
3.3.	Pin Assignment on the Back Side.....	7
3.4.	Pin Assignment.....	7
3.5.	Description of Interfaces .....	9
<b>4.</b>	<b>Installation Instructions</b>	<b>10</b>
4.1.	Scope of Delivery.....	10
4.2.	Environmental Conditions.....	10
4.3.	Minimum Energy Consumption Mode.....	10
4.4.	Types of Installations .....	11
4.4.1.	Installation in the Control Cabinet.....	11
4.4.2.	Installation on the Wall Bracket .....	11
4.4.3.	Installation on a Support Arm .....	11
4.5.	Program ISMM for Temperature Control .....	12
<b>5.</b>	<b>Commissioning Instructions</b>	<b>13</b>
5.1.	Turning the IPC On and Off .....	13
5.2.	Operation .....	13
5.3.	Description of Function/Control Keys .....	13
5.3.1.	Keyboard Configuration .....	14
5.3.1.1.	Power Switch .....	14
5.3.1.2.	Registration.....	15
5.3.1.3.	Function Keys .....	16
5.4.	Initial Setup .....	17
5.5.	Transponder Reader Integration.....	18
5.5.1.	HID / Key-Emulator .....	18
5.5.2.	SDK Interface .....	18
<b>6.</b>	<b>Help in case of Malfunctions</b>	<b>19</b>
6.1.	Troubleshooting .....	19
6.2.	Restore Delivery State.....	19
6.3.	Calibrate Touch Screen .....	20
<b>7.</b>	<b>Technical Appendix</b>	<b>21</b>
7.1.	Appendix A – Technical Data .....	21
7.2.	Appendix B – I/O Card (2 x Digital Input, 2 x Relay Output) .....	22
<b>8.</b>	<b>Index</b>	<b>24</b>

## 1. For Your Safety

### Safety Information for Datafox Products



The device must only be operated according to the instructions given in the manual.  
Do not insert any foreign objects into the openings and ports.  
The device must not be opened. All maintenance work must only be performed by authorized specialists.



Some devices contain a lithium ion battery or a lithium battery.  
Do not throw into fire!

#### Caution!

Supply voltage: 12 V DC via DC connector  
12 V / 24 V flat plug for vehicle connection

See respective type label / technical data.

The device must only be operated with a power-limited power supply according to EN 60950-1. If you do not observe these instructions, the device may be damaged.

The following temperature ranges must be observed:

Environmental temperature range 0 °C (32 °F) to 40 °C (104 °F)

See also chapter „ambient conditions“.



In areas with cellphone ban, GSM, WLAN and other cellular modems must be turned off.

Persons with heart pacemakers:

When using the device, maintain a distance of at least 20 cm between the heart pacemaker and the device in order to avoid possible interferences.

Turn the device off immediately if interferences are assumed.

**Protection class:** Observe the technical data of the respective device.

## **1. Introduction**

### **1.1. Structure of the Documentation**

The manual contains a change history as well as a general part with safety information, the introduction and information concerning system requirements and system structure.

The general part is followed by the main part of the manual. It contains the chapter Product Description. In this chapter, device-specific components are described as well as the device's functions.

The final part of the manual provides technical data about the device and a glossary whose purpose it is to ensure a consistent understanding between user and manufacturer.

### **1.2. Guarantee Restriction**

All installers are responsible for the use of the device and its accessories in accordance with its intended purpose and in compliance with the applicable laws, standards and directives.

All data in this manual has been checked carefully. Nevertheless, errors cannot be excluded. Therefore, we offer no guarantee nor accept any liability for consequences that derive from errors of this manual. Of course we are grateful if you point out errors to us. We reserve the right to make modifications in respect of technical progress. Our general terms and conditions of business apply.

### 1.3. Typography of the Documentation

SW ..... Abbreviation for software  
 HW ..... Abbreviation for hardware  
 GV ..... Abbreviation for global variable  
 <Name;Software Version.pdf> ..... File names



**Note:**

Useful information which helps you avoiding possible mistakes during the installation, configuration and commissioning is given here.



**Caution:**

Here, notes are provided which must be strictly observed. Otherwise, malfunctions of the system will occur.

### 1.4. Important General Notes



**Caution:**

Use the devices only according to regulations and follow the installation, commissioning and operating instructions. Installation and commissioning may only be performed by authorized specialists.

**Subject to technical alterations.**



**Caution:**

Due to technical development, illustrations, function steps, procedures and technical data may vary slightly.

Numerous optional features, such as bar code reader, transponder reader, digital inputs etc., enable you to use the device for:

- PZE - Personnel time recording
- AZE - Order time recording
- BDE - Operating data recording (I/O-processing)
- ZK - Access control
- FZDE - Vehicle data recording / telematics

This manual describes the functionality of the IPCand explains its characteristic features. For example, installation, operation and equipment of the device are described.

## 2. Intended Use and Environmental Protection

### 2.1. Regulations and Notices

According to the current state of the art, measures were taken to ensure that the device meets the technical and legal regulations as well as safety standards. Nevertheless, malfunctions due to interferences through other devices can still occur.

Please observe local regulations when using the device.

### 2.2. Power Supply

Only operate the device externally with a limited power source in accordance with EN 60950-1.

Power supply of IPC devices:           12V DC power adapter with DC connector  
  12V/24V flat plug for vehicle connection

If the devices run with rechargeable batteries, note the instructions in chapter "Rechargeable Battery".



#### **Caution:**

In the event of non-compliance with these instructions, the device or the battery (if any) can be damaged or destroyed!

### 2.3. Environmental Influences

Extreme environmental influences may damage or destroy the device and should be avoided. This includes fire, extreme sunlight, water, extreme cold and extreme heat.

See respective type label of the device

### 2.4. Handling of the Touch Screen Display

Only use articles made of soft plastic when working with the touch screen display. Avoid any contact between the display and hard or sharp objects. Do not place any objects on the display: risk of breakage. If the display is damaged, avoid any contact with possibly escaping liquids. If you have come in contact with such liquids, rinse thoroughly with water.

### 2.5. Maintenance / Repair

, Datafox devices are maintenance-free and must only be opened by authorized professionals. In case of defects, please contact your dealer or the Datafox service hotline.

In order to remove impurities, only use a dry or at the maximum a slightly damped cloth.

Never use scouring or corrosive cleaning agents.

### 2.6. Further Notices

Do not expose the device to strong magnetic fields, especially during operation.

Operate the slots and connections of the device only with the appropriate intended equipment.

Ensure that the device is secured during transport. For reasons of safety, do not use the device while driving a vehicle. Also ensure that technical equipment of your vehicle is not compromised by the device.

### 2.7. Disposal

Observe local regulations concerning the disposal of packaging material, used batteries and scrapped electrical equipment.

This product complies with the EU Directive No. 2002/95/EC, its appendices and the Council Decision laying down the restrictions of the use of hazardous substances in electrical and electronic equipment.

The device is covered by the European Directive on Waste Electrical and Electronic Equipment which came into force on February 13, 2003 and was translated into the legislation of the Federal Republic of Germany on August 18, 2005.



Do not dispose the device in domestic waste!

As the user, it lies within your responsibility to dispose electrical and electronic equipment via the designated collection facilities. The correct disposal of electrical and electronic equipment protects human life and the environment.

For more information regarding the disposal of electrical and electronic equipment, please contact your local authorities or waste disposal companies.



### 3. Product Description

#### 3.1. Purpose

The IPC Vario 10 is a multifunctional industrial PC suitable for data collection and information display. Due to its resilient and closed plastic housing, it is suitable for use under extreme environmental conditions, e.g. in industrial production or logistics.

Thanks to the Intel® Atom™ processor, only low heat development occurs, which contributes to high performance, reliability and durability of the IPC.

The high-resolution display with built-in touch operation facilitates good readability and easy handling of the device. Due to built-in modules, such as transponder reader or fingerprint module, as well as the uncomplicated connection of peripherals, the IPC Vario 10 is an ideal all-rounder for use in recording of labor time, production, machine and process data as well as inventory management. Applications based on Windows can be installed and extensive input masks or technical drawings be displayed. Test plans and formulas can be filled in on site or, if necessary, online. All information needed is available at the workplace or on the central server at any time. For entry via touch a freely configurable and scalable virtual keyboard is available for free.

#### 3.2. Controls at the Front Side



### 3.3. Pin Assignment on the Back Side

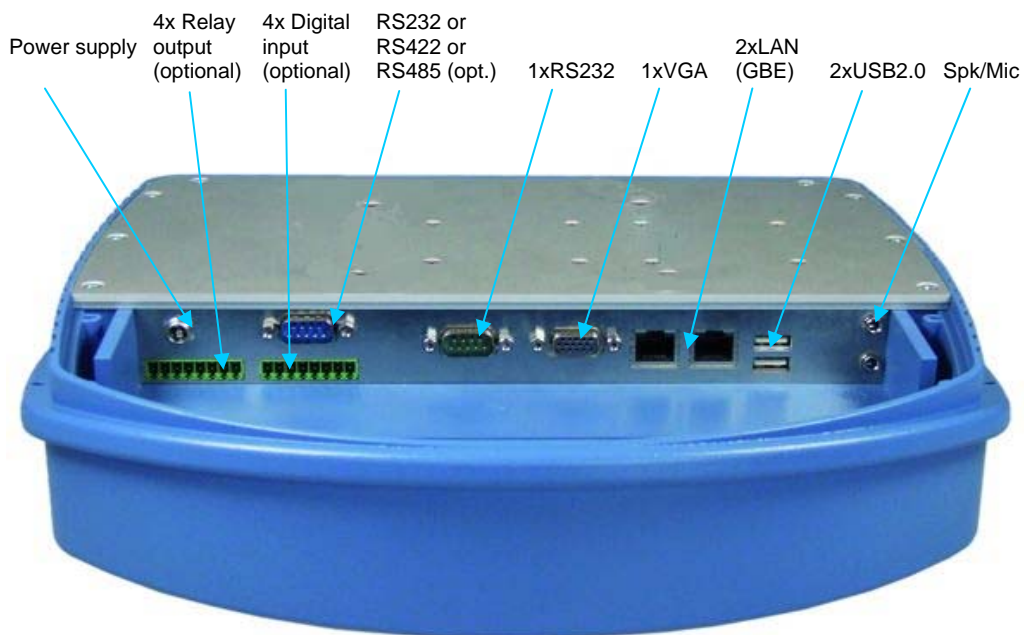

### 3.4. Pin Assignment

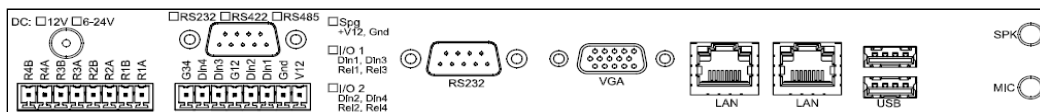

**SPK**  
Speakers / headphones Output



Pin	Signal	Pin	Signal
inside1	left out	outside	GND
inside2	right out		

**MIC**  
Microphone Input



Pin	Signal	Pin	Signal
inside	mic in	outside	GND

**USB (2 x)**  
USB 2.0 Port

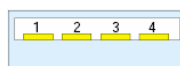

Pin	Signal	Pin	Signal
1	+5 V	3	D+
2	D-	4	GND

**LAN (2 x)**  
Network Connection  
10 / 100 / 1000 Mbit

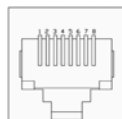

Pin	Signal	Pin	Signal
1	D1+	5	D3-
2	D1-	6	D2-
3	D2+	7	D4+
4	D3+	8	D4-

**VGA**

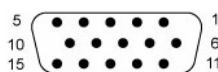

Pin	Signal	Pin	Signal
1	RED	9	VCC
2	GREEN	10	GND
3	BLUE	11	NC
4	NC	12	DDCDAT
5	GND	13	HSYNC
6	CRT-	14	VSYNC
7	GND	15	DDCLK
8	GND		

**RS232**  
Serial Interface  
(COM1)

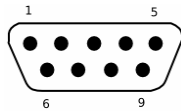

Pin	Signal	Pin	Signal
1	DCD	6	DSR
2	RXD	7	RTS
3	TXD	8	CTS
4	DTR	9	RI
5	GND		

**RS232**  
(COM2) – optional

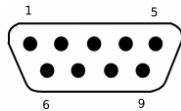

Pin	Signal	Pin	Signal
1	DCD	6	DSR
2	RXD	7	RTS
3	TXD	8	CTS
4	DTR	9	RI
5	GND		

or as

**RS422 or RS485**  
Serial Interface

Pin	Signal	Pin	Signal
1	TX-	4	RX-
2	TX+	5	GND
3	RX+	6..9	-----

**DIGIN (2 x / 4 x)**  
Digital Inputs  
optional  
[\(Connection see Appendix B\)](#)



Pin	Signal	Pin	Signal
1	V12	5	GND12
2	GND	6	DIN3
3	DIN1	7	DIN4
4	DIN2	8	GND34

**RELOUT (2 x o. 4x)**  
Relay Outputs  
optional  
[\(Connection see Appendix B\)](#)



Pin	Signal	Pin	Signal
1	R1A	5	R3A
2	R1B	6	R3B
3	R2A	7	R4A
4	R2B	8	R4B

**Power Supply**



12V power adapter (DC connector)

Pin	Signal	Pin	Signal
inside	+12 V	outside	ground

or

or



12V / 24V vehicle connection (flat plug)

Pin	Signal	Pin	Signal
red	BAT+	white	IGN
black	BAT-		

**Protective Grounding**



Grounding bolt on the backside

### 3.5. Description of Interfaces

#### **SPK** (Headphones / speaker port)

Via this jack socket, headphones or speakers can be connected with a 3.5 mm jack plug (stereo).

#### **MIC** (Microphone port)

This jack socket is used for connecting a microphone with a 3.5 mm jack plug.

#### **USB** (Universal Serial Bus port)

Via both USB 2.0 ports, external USB devices can be connected.

#### **LAN** (Local Area Network port)

Via both RJ45 sockets, the device can be connected to an Ethernet network, for example. For this purpose, a Gigabit Ethernet capable cable has to be used.

#### **VGA** (Video Graphics Array port)

This 15-pin socket is used for connecting an analog monitor with a resolution of max. 2048 x 1536 pixels.

#### **RS232** (Serial interface – COM1)

Via this interface, serial peripherals are connected to the device.

#### **RS232 or RS422 or RS485** (Serial interface – COM2)

This optionally available interface is designed either as classical RS232 interface or as differential serial RS422 or RS485 interface. The selection of one of the three variants takes place on-board and cannot be influenced by the user.

#### **DIGIN** (Digital Input; [Connection see Appendix B](#))

Via up to four optionally available floating inputs, slow digital data (e.g. production / standstill) can be recorded.

#### **RELOUT** (Relay Output; [Connection see Appendix B](#))

These up to four optionally available PhotoMOS relay outputs enable the switching of external voltages.

#### **Power supply**

Connection of the supply voltage of the device.



#### **Note:**

##### **Protective grounding**

Via this port, a low-impedance connection to a central grounding point must be established in order to discharge interferences or static charges.

## 4. Installation Instructions

The proper installation of the IPC is essential for a convenient operation of the device. The device can be installed directly (e.g. in a control cabinet) or using an optionally available wall bracket or support arm. The location where the device is to be installed should not be exposed to direct sunlight and reflections should be avoided as far as possible.

### 4.1. Scope of Delivery

Please ensure that the delivery is complete and undamaged before beginning with the installation or commissioning. If the delivered goods are incomplete or damaged, please contact us within 14 days after receipt of the goods.

### 4.2. Environmental Conditions

The IPC can be operated at an ambient temperature of +0 °C to +40 °C and at a relative humidity of max. 90% (non-condensing).

After transporting the IPC, wait until the device has reached the ambient temperature before starting the commissioning. In case of large temperature and humidity fluctuations, condensation can lead to the formation of moisture inside the device, which can cause an electrical short circuit.

Due to the fanless operation and the compact construction, different measures have to be taken depending on the ambient temperature.



**Caution:**

When the system temperature reaches more than 50 °C, the brightness of the display is reduced automatically in order to reduce the heat development inside the device. In such a case, please ensure sufficient cooling.

Description	At temperature [°C]		
	0 - 25	0 - 35	0 - 40
Power supply may be located in the connection compartment	X		
Minimum distance from wall: 10 – 20 mm.	X	X	
Minimum distance from wall: 50 mm.			X
Suspension at metal plate		X	X
Ensure sufficient air exchange on the back side			X
Operation in "minimum energy consumption" mode necessary		X	X
System temperature must not exceed 62 °C (control via ISMM)	X	X	X

### 4.3. Minimum Energy Consumption Mode

The Datafox IPCs are delivered with "minimum energy consumption" mode set. The deactivation of the minimum energy consumption mode has to be enabled in the Windows registry first. For more information see chapter „[Registration](#)“.

Please note that the setting of the minimum energy consumption mode contributes to a reduction of temperature inside the IPC. Lower temperatures always have positive effects on the product life.

## 4.4. Types of Installations

### 4.4.1. Installation in the Control Cabinet

The industry PC can be installed in a control cabinet. For this purpose, a corresponding opening at the control cabinet wall is required.

(A stencil for the opening is available at the product DVD <Datafox DVD\Industrie-PCs\IPC, SW und Doku\IPC Optionen und Zubehör\Schaltschrankmontage Vario10>.)

When installing the device in the control cabinet, ensure that air circulation on the back side of the IPC is possible. If necessary, this can be achieved by a fan in the cabinet. You can control the installation conditions with the help of the program ISMM. The system temperature must not exceed 60 °C.

### 4.4.2. Installation on the Wall Bracket

An alternative method for installing the IPC at a wall or machine is the optionally available wall bracket.

Besides an easy installation, the bracket allows for positioning the device in three operation angles (15 °, 22.5 ° and 30 °).



### 4.4.3. Installation on a Support Arm

With the also optionally available support arm, the IPC can be installed on a desk, wall or machine.

Via four axes of rotation, the IPC can be turned to the desired operation position.



## 4.5. Program ISMM for Temperature Control

The program ISMM is included in delivery serves for measuring the system temperature on the board of the IPC. The system temperature must not exceed 62 °C; the temperature of the CPU must not exceed 85 °C.

Calling the program:

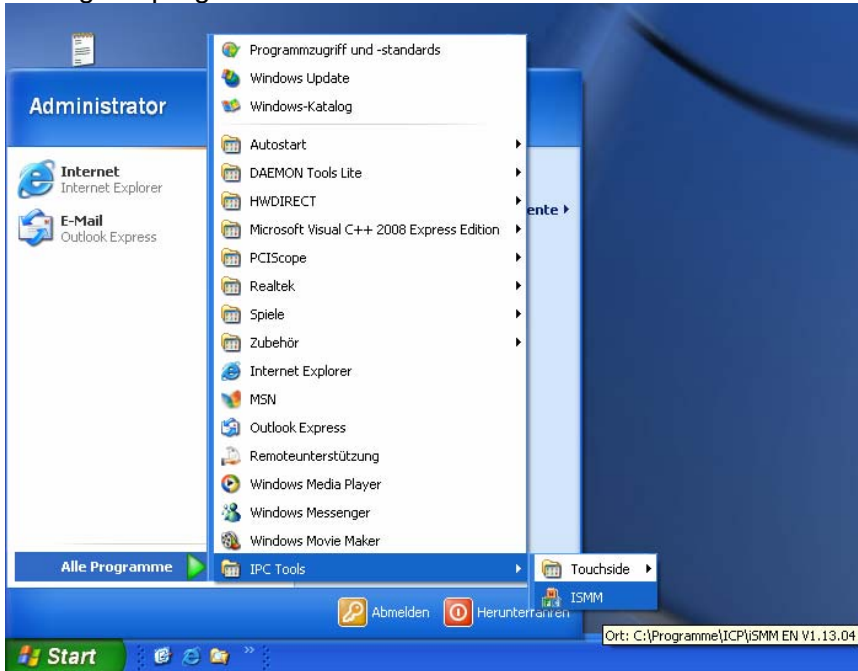

In the program, select the tab "Temp Page". Here, you can see the temperatures.

The screenshot shows the ISMM (WAFER-ATOM) V1.13 software interface. The 'Temp Page' is selected, displaying a table of temperature readings. A yellow dashed box highlights the 'SYS\_TEMP' row, and a yellow arrow points to it from a callout box. The callout box contains the text 'SYS\_TEMP' and 'Must not exceed 62 °C. !'.

Item	Status	High Limit	Low Limit
CPU_TEMP	24.00	30.00	10.00
SYS_TEMP	33.00	40.00	10.00

Refresh time (Sec) : 1 **apply**

Temperature units:  °C  °F

**INTELLIGENT SYSTEM MANAGEMENT MODULE**

## 5. Commissioning Instructions

### 5.1. Turning the IPC On and Off

The IPC is turned on by pressing the on/off button once. If the operating system Windows® is installed, the function of the button can be programmed via the power management. The PC is turned off when the button is pressed longer than 4 seconds.



**Caution:**

If the operating system is not shut down properly, data loss may occur when turning off the device.

If necessary, the Advanced Power Management configuration can be changed via the Power Configuration Menu of the BIOS (see *Vario10\_Board\_man\_v1.00.pdf*).

### 5.2. Operation

The device has a touch screen and 19 function and control keys as default. In order to ensure a reliable operation and to avoid damaging the controls, observe the following notes:

- The resistive touch screen must only be operated with fingers, gloves or a stylus.
- The membrane keys (function and control key, on/off button) must be operated only with fingers.
- When using gloves, ensure that they are free of sharp-edged adhesions as for example glass fragments or cuttings.

### 5.3. Description of Function/Control Keys

<b>F1</b> ....	The assignment of the function keys depends on the software used.
← ↑ ↓ →	Move the cursor one step in the corresponding direction.
<b>ESC</b>	Cancel running tasks of the computer.
↵	Confirm the input.



## 5.3.1. Keyboard Configuration

### 5.3.1.1. Power Switch

You can set the function of the power switch as follows.

Choose „Power“.

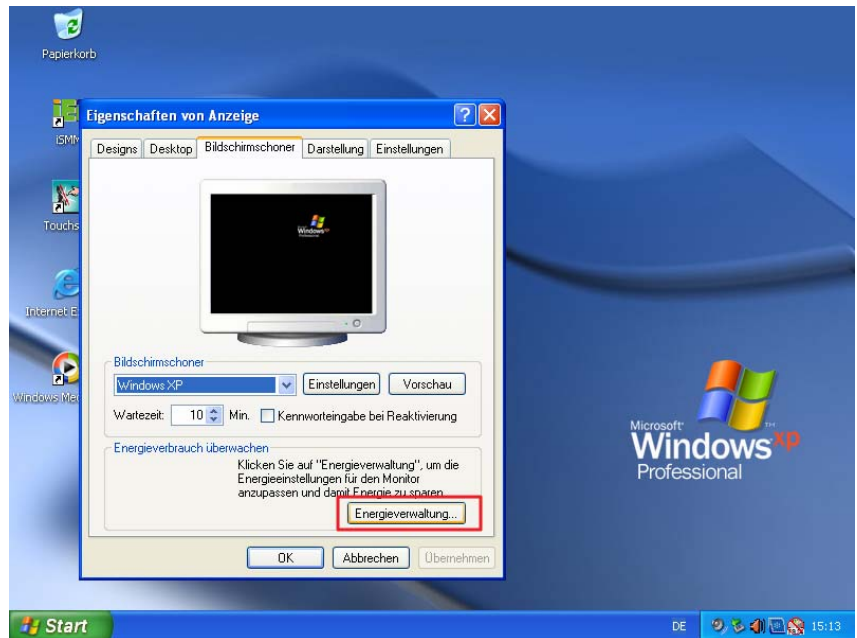

Set the behavior.

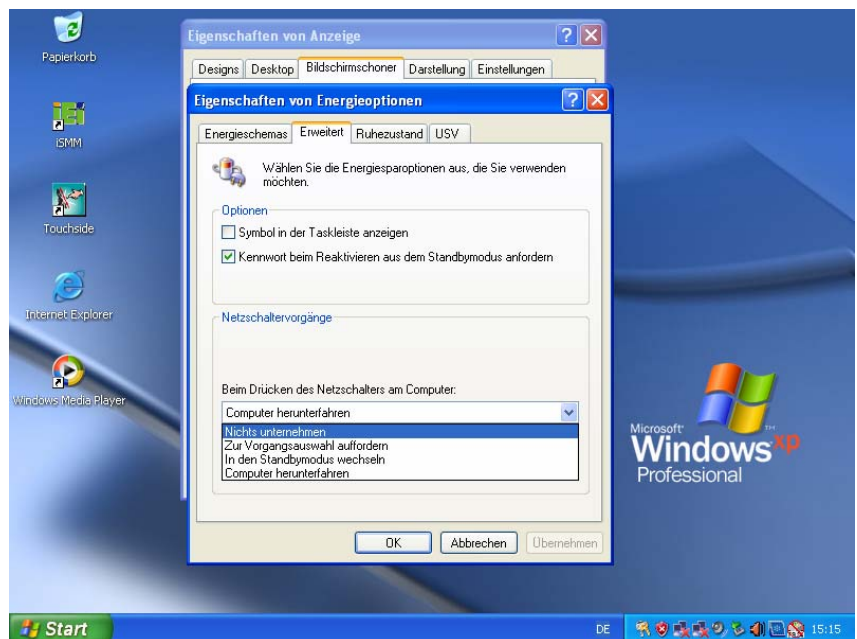

**Note:**

If you do not have access to the power options, you must activate the user in the registration.

### 5.3.1.2. Registration

Open registration:

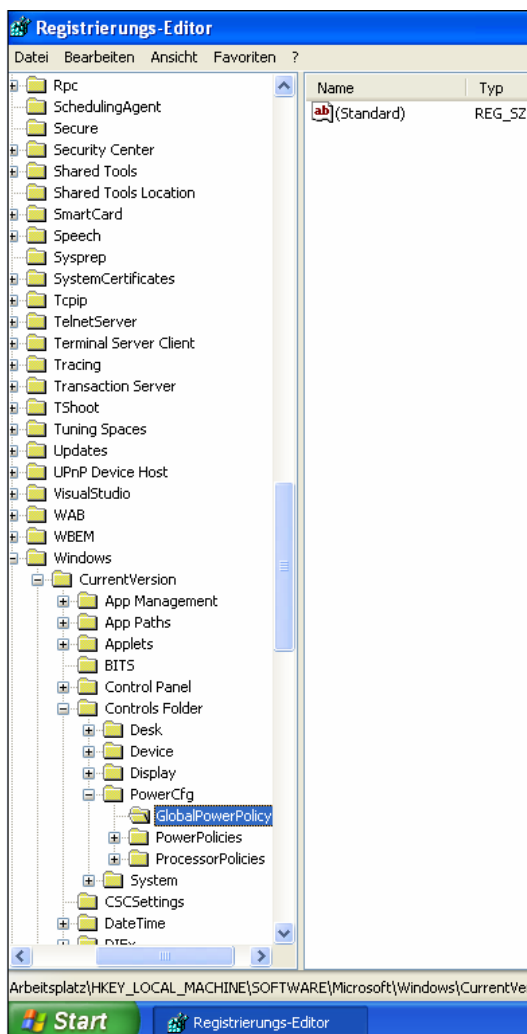
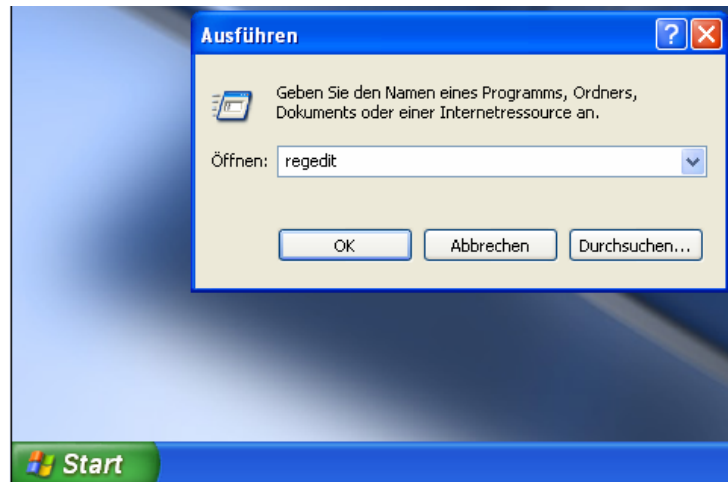

Open permissions for „GlobalPowerPolicy“

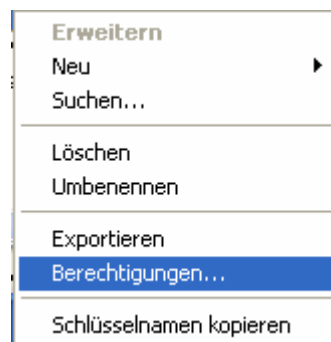

Add permission for user

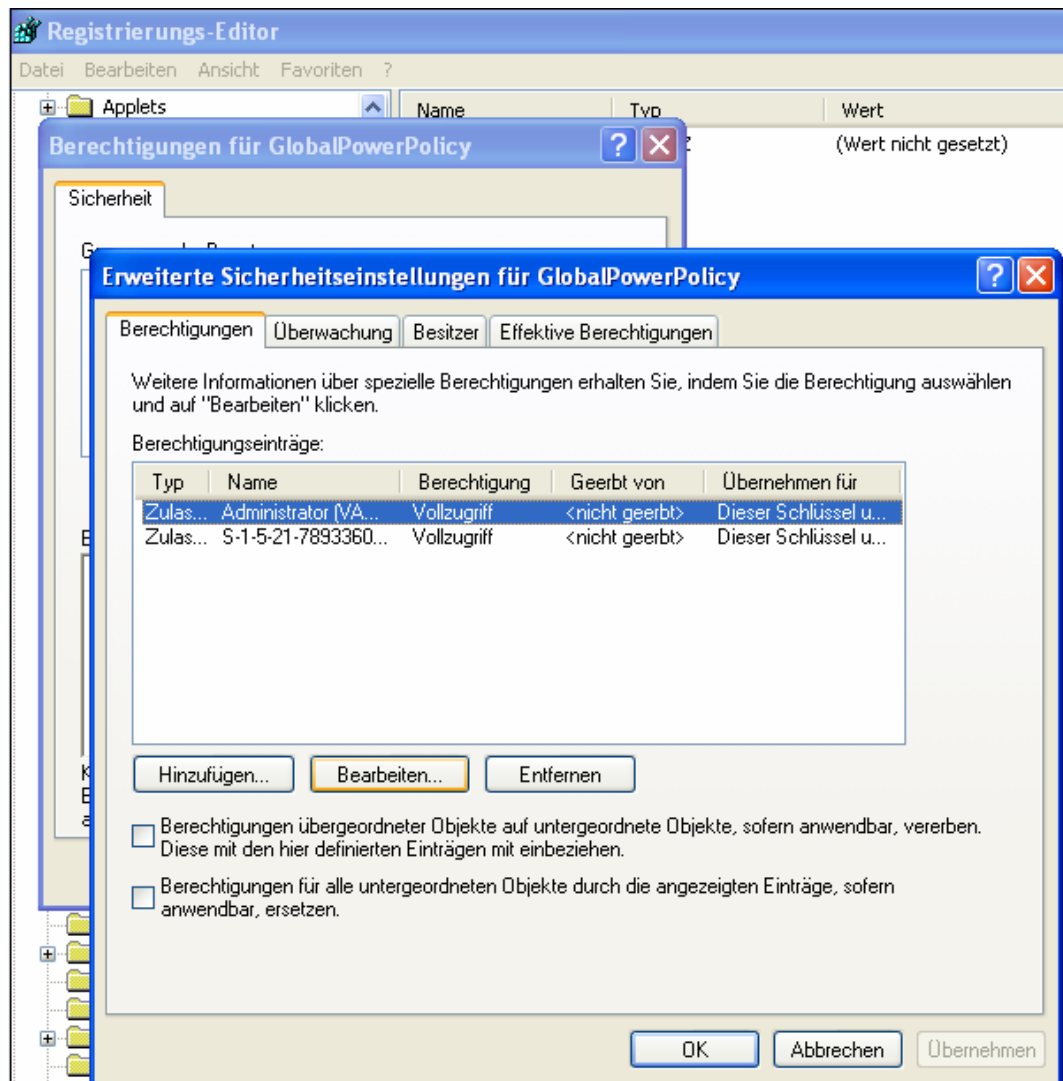

**Note:**

If you add a new group or new user and assign only additional rights as described, you can enable the access to the power options for specific users only. To restore the original settings, double-click on the previously saved backup file of the key.

### 5.3.1.3. Function Keys

The assignment of the function keys cannot be changed by software settings. The deactivation of function keys has to be specified when ordering the device.

## 5.4. Initial Setup

If you ordered the IPC with the operating system Windows® pre-installed, Windows® is directly booted from the hard disk during the first commissioning. During initial setup the loading process takes a bit more time. As soon as the operating system has completed loading, you are requested by dialogs to set-up the system by entering some individual information.



### **License Agreement:**

Please read the license agreement displayed during the initial setup carefully. It contains important legal notes concerning the use of the software product. Only if you agree, are you allowed to use the software pursuant to the terms and conditions of the license agreement.

After finishing the initial setup, the operating system including pre-installed drivers and the software for data exchange including optionally available and already integrated additional internal modules are available to you.



### **Note:**

For both the initial setup of the IPC and changes in the BIOS settings a USB keyboard is necessary. Before turning the device on, the keyboard must be connected via one of the USB ports at the back side of the device.

## 5.5. Transponder Reader Integration

An RFID reader can be integrated either via an SDK interface or via a key emulator.

Type of Reader	SDK	HID
<b>Transponder reader integrated. Unique EM4102, Hitag1, Hitag2, HitagS, Hewi EM4450</b> reading distance up to 8 cm. Reading and writing. Control via protocol or key emulator.	X	X
<b>Legic transponder reader</b> integrated, reading distance up to 4 cm. Reading only. Control via protocol.or key emulator	X	X
<b>Mifare transponder reader</b> integrated, reading distance up to 4 cm. Reading only. Control via protocol.	X	
<b>Mifare transponder reader</b> integrated, reading distance up to 4 cm. Reading only. Control via protocol or key emulator.	X	X
<b>Mifare-Desfire integrated</b> , reading distance up to 2,5 cm with ISO card. Control via protocol.	X	
<b>Reader for SimonsVoss transponder.</b> Reading only. Control via protocol.	X	
<b>iButton</b> integrated. Read head on the front side.	X	

### 5.5.1. HID / Key-Emulator

The key emulator provides an HID (human interface device) interface which acts like a keyboard. When you hold the transponder in front of the reader, the data are written out of the transponder at the cursor position.

In a setup program (reader setup) you can determine which data are to be read out of the transponder.

For transponder readers using the key emulator, the key emulator has been installed. You can find the key emulator and the program for setting the transponder reader on the product DVD under „\_Datafox DVD\Industrie-PCs\IPC, SW und Doku\IPC Optionen und Zubehör\Transponderleser“.

 **Note:** You have to stop the key emulator first in order to make settings with the reader setup.

**Interface:** For the connection of the reader **Com6** is used.

### 5.5.2. SDK Interface

The connection via SDK interface is a bit more complicated and requires knowledge in programming. Commands are provided giving you access to the reader. The reader can then be integrated in an application.

For more information on reader integration see our product DVD:

„\_Datafox DVD\Industrie-PCs\IPC, SW und Doku\IPC Optionen und Zubehör\Transponderleser“.

## 6. Help in case of Malfunctions

In case of malfunctions, first check all cable connections for intactness and correct position. Sometimes malfunctions have trivial causes. If the following measures for troubleshooting remain without success, please contact your dealer.

### 6.1. Troubleshooting

Problem	Possible Cause	Measures
Operating display is not illuminated	- missing power supply	- check power supply
IPC does not start	- missing power supply	- check power supply
Screen is black	- IPC is turned off - missing power supply - IPC is in standby mode	- turn IPC on - check power supply - touch the screen
Screen flickers	- faulty fluorescent bulb - faulty control electronics	- call service



**Note:**

Pixel errors in the TFT display are production-caused and represent no complaint-reason.

### 6.2. Restore Delivery State

If you want to restore the delivery state of the device, proceed as follows:

- When starting the device, you can see the following screen for 10 seconds.

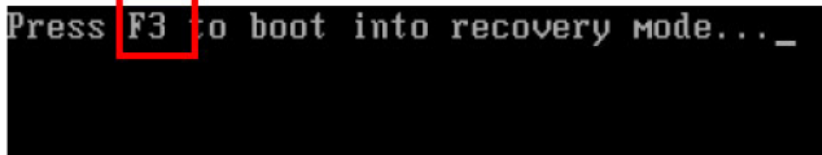

- Press F3.

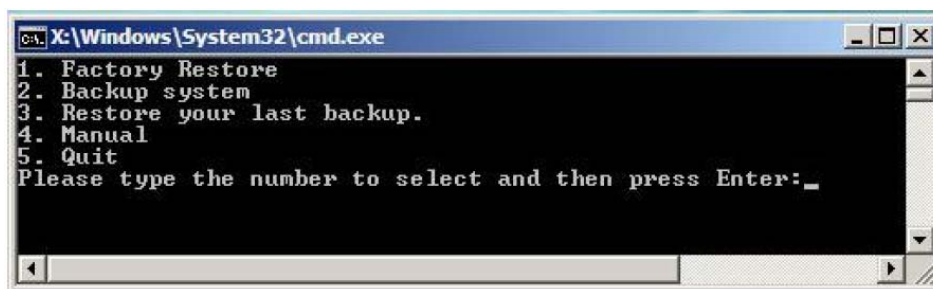

- Restore the delivery state by pressing key 1.

For more information see our product DVD: „\_Datafox DVD\Industrie-PCs\IPC, SW und Doku\IPC Software\ One Key Recovery“.

### 6.3. Calibrate Touch Screen

To calibrate the touch screen, proceed as follows:  
Open the configuration program "Configure Utility".

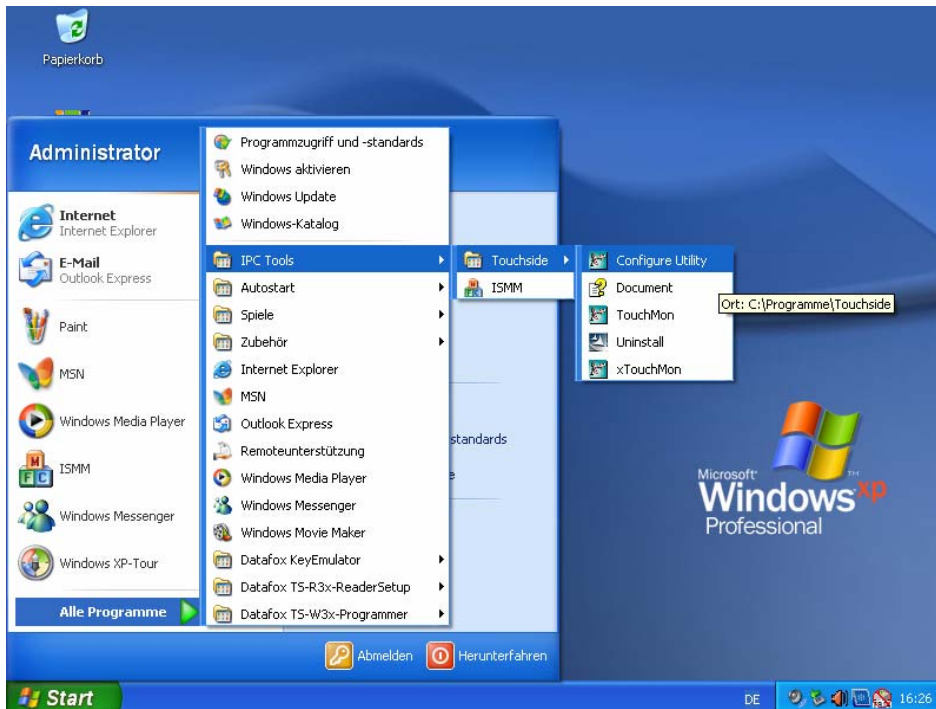

Click on "4-Punkte-Kalibrierung" and follow the instructions.

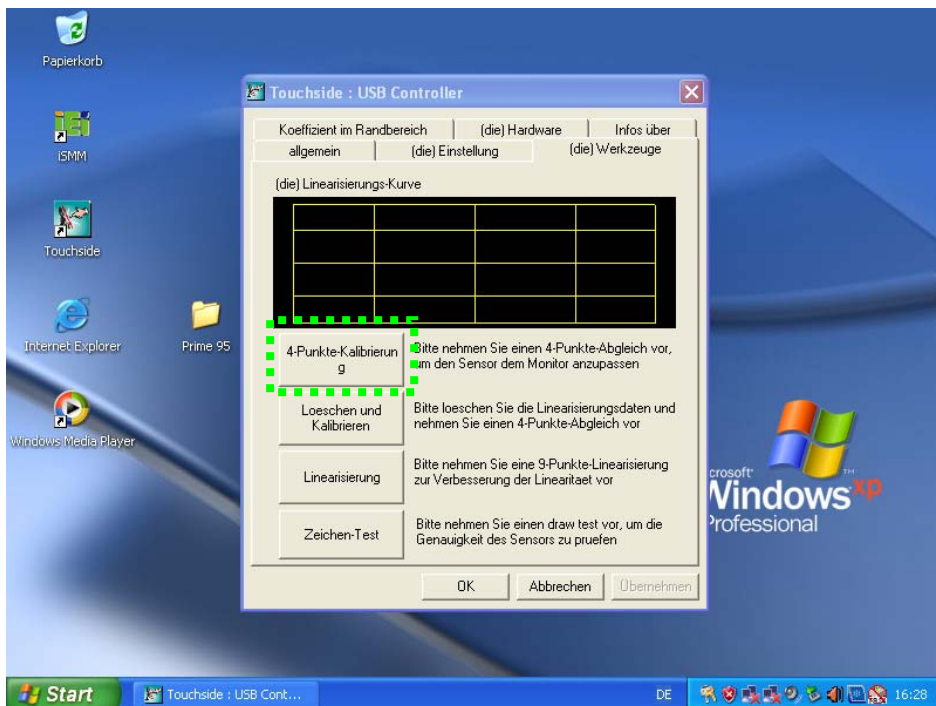

## 7. Technical Appendix

### 7.1. Appendix A – Technical Data

<b>Box</b>	Completely closed and fanless, silent and dirt resistant	●
	Wall thickness 6 mm for heavy duty use	●
<b>Display</b>	<b>Vario10:</b> 26,4 cm [10,4"] TFT 800 x 600 (SVGA) - 400 cd/m <sup>2</sup>	●
	<b>Vario10:</b> 26,4 cm [10,4"] TFT 1024 x 768 (XGA) - 400 cd/m <sup>2</sup>	○
	<b>Vario12:</b> 30,7 cm [12,1"] TFT 1024 x 768 (XGA) - 400 cd/m <sup>2</sup>	●
<b>Touch</b>	Resistive analog touch screen (4-wire)	●
<b>Keys</b>	Vario 10: 19 keys / Vario 12: 18 keys	●/○
<b>CPU</b>	Intel® Atom™ 1,6 GHz	●
<b>Graphics Processing Unit</b>	Intel® 945GSE	●
	Memory: max. 32MB shared	●
<b>Hard Disk</b>	SSD (Solid State Drive) 60 GB	●
	HDD (Hard Disk Drive) / SSD (Solid State Drive)	○
<b>Memory</b>	1 GB	●
	2 GB	○
<b>Interfaces</b>	1 x Ethernet [GbE]	●
	2 x USB 2.0	●
	1 x RS232	●
	1 x RS232/422/485	○
	1 x VGA	●
	1 x Sound [Spk / Mic]	●
<b>Additional Options</b>	Transponder reader - built-in (Unique, Hitag, Mifare, Legic, ....)	○
	Fingerprint reader - built-in (IdenCom Biokey)	○
	Up to 2 x I/O cards - built-in (2 x dig. inputs, 2 x relay outputs)	○
	<b>Technical Data of Inputs</b> 1) The maximum detectable frequency of the input signal depends on the sampling rate. The sampling rate is decisively dependent on the operating system, the application software and the processor load.	
	<b>Technical Data of Outputs</b> 2) The maximum switching frequency of the output. The real switchable frequency of the output is dependent on the operating system, the application software and the processor load.	
	1 x I/O card - built-in (2 x dig. / 2 x analog inputs)	○ <sup>1)</sup>
<b>Specifications</b>	On-screen keyboard, freely configurable and scaleable - free of charge	●
	Safety class: IP65 (front side)	●
	power consumption: 25 W (basic device)	●
	operating temp. range: 0°... 40° C	●
	dimensions: 312 x 312 x 60 mm [12,3 x 12,3 x 2,4"]	●
	weight: ca. 3.2 kg (basic equipment)	●
<b>Operating System</b>	certification: CE nach/ according to EN 55022, EN 55024	●
	Windows XP Professional for Embedded Systems	○
	Windows XP Embedded POSReady	○
<b>Accessories</b>	OS driver for XP Pro and Linux	●
	100-240VAC power adapter	○
	6V-24V built-in power supply //(for use in vehicles)	○
	barcode reader (USB interface)	○
	Fingerprint desktop reader (connection via RS232 interface)	○
wall mount kit	○	



## 7.2. Appendix B – I/O Card (2 x Digital Input, 2 x Relay Output)

The I/O card serves for detecting two digital input signals (e.g. production/standstill) and for switching two voltages. The electrically isolated inputs are suitable for nominal voltages of up to 32V DC. Always two adjacent channels share a reference. Thus, signals of other devices can be connected without causing compensation currents on the ground line. The PhotoMos relay outputs can switch currents of up to 250 mA. The Vario 10 can be equipped with two of these I/O cards at most, so that four digital inputs and four relay outputs are available.

Internally, both I/O cards are directly connected to the chip set, so that they can be operated via the application program with the help of an attached ismm.dll (CD directory "..\IPC Optionen und Zubehör \IO-Karte\iSMM SDK v1.2"). For a simple function control of the inputs and outputs, the pre-installed program iSMM (intelligent **S**ystem **M**anagement **M**onitor) can be used.

**Note:**  If the IPC is signed in at a network domain, the user signed in must have local administrator rights in order that the I/O card works properly using the ismm.dll. The same applies for the program iSMM.

The interfaces for the inputs and outputs are on separate terminal strips.

### Pin Assignment of Digital Inputs

PIN	Designation	Meaning	☒ Spg	☒ I/O1	☒ I/O2
1	V12	12V Output (max. 0.1A)	X		
2	GND	Device ground	X		
3	DIN1	Input 1		X	
4	DIN2	Input 2			X
5	G12	Ref. for input 1 and 2		X	X
6	DIN3	Input 3		X	
7	DIN4	Input 4			X
8	G34	Ref. for input 3 and 4		X	X

### Pin Assignment of Relay Outputs

PIN	Designation	Meaning	☒ Spg	☒ I/O1	☒ I/O2
1	R1A	Output 1		X	
2	R1B	Ref. for output 1		X	
3	R2A	Output 2			X
4	R2B	Ref. for output 2			X
5	R3A	Output 3		X	
6	R3B	Ref. for output 3		X	
7	R4A	Output 4			X
8	R4B	Ref. for output 4			X

### Technical Data of Inputs

Parameters	Symbol	Min.	Typ.	Max.	Unit
Input Voltage	$V_{in}$	0		32	V
Max. Input Voltage for Low Detection	$V_{ILmax}$			1	V
Min. Input Voltage for High Detection	$V_{IHmin}$	3.5			V
Input Current ( $V_{IN}=12V$ )	$I_{IN}$		3.6		mA
Input Frequency <sup>1)</sup>	$F_{in}$			5	kHz
Isolation Voltage ( $t=10s$ )	$V_{ISO(rms)}$		3.75		kV

3) The maximum detectable frequency of the input signal depends on the sampling rate. The sampling rate is decisively dependent on the operating system, the application software and the processor load.

### Technical Data of Outputs

Parameters	Symbol	Min.	Typ.	Max.	Unit
Switching Voltage DC (peak AC)	$V_L$	0		32	V
Switching Current DC (peak AC)	$I_L$			0.25	A
Peak-Switching Current ( $t=100ms$ )	$I_{Peak}$			1	A
Leakage Current	$I_{Leak}$		1		$\mu A$
Output Resistance	$R_{ON}$		0.83	2.5	$\Omega$
Switching Frequency <sup>2)</sup>	$F_L$			100	Hz
Isolation Voltage	$V_{ISO(rms)}$		1.5		kV

4) The maximum switching frequency of the output. The real switchable frequency of the output is dependent on the operating system, the application software and the processor load.

### Connection example:

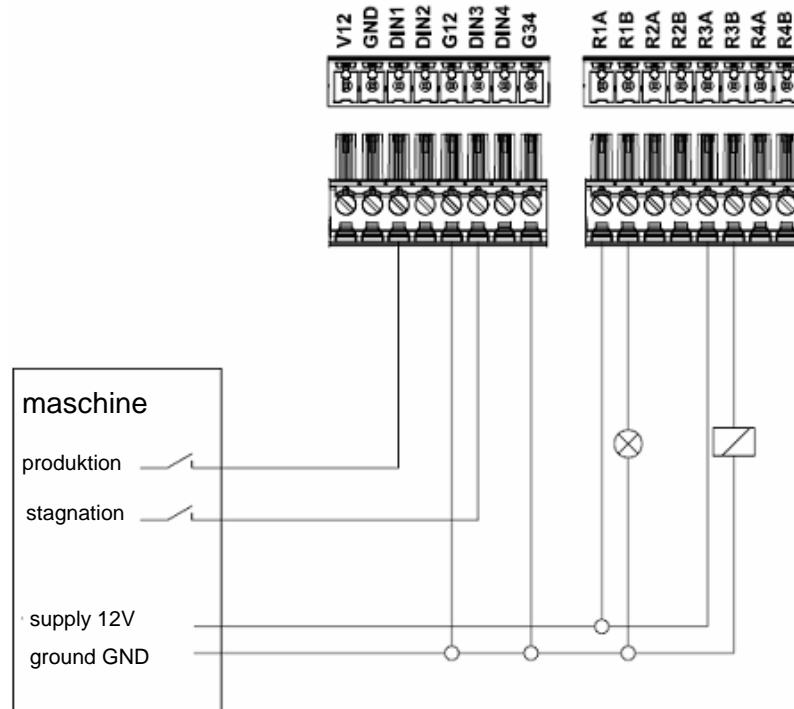

## **8. Index**

### **C**

Commissioning Instructions 13  
Connectings 7

### **D**

Delivery Condition 20  
Disposal 4

### **E**

Energie 4

### **F**

For Your Safety 1

### **H**

Help in case of Malfunctions 19  
HID 18

### **I**

Installation 11  
Installation Instructions 10  
Intended Use and Environmental Protection 4  
Introduction 2

### **K**

Keys 14

### **M**

Maintenance 4

### **O**

Operating temperature 10

### **P**

perating temperature 10  
Product Description 6

### **R**

Repair 4  
RFID reader 17

### **S**

Safety 1  
SDK 19

### **T**

Technical Appendix 21  
Temperature 10  
Temperature control 12